

InstroTek® Incorporated

CoreLok® Operator's Guide



**InstroTek®
Inc.**

CoreLok® Operator's Guide

All Rights Reserved

InstroTek, CoreLok and associated logos are trademarks of InstroTek, Inc. and may be subject to one or more U.S. and foreign trademark restrictions or applications. Other trademarks are property of their respective owners.

Instrotek®, Incorporated

Copyright © February 2011
v.23

All Rights Reserved

No part of this manual may be reproduced for any purpose without the written permission of Instrotek, Inc.

5908 Triangle Drive • Raleigh, NC 27617
Tel (919) 875-8371 • Fax (919) 875-8328 • E-mail Sales@InstroTek.com
www.instrotek.com

This product is covered under the below listed US Patent Numbers as well as other International Patents:
6817243, 6817230, 6684684, 6668647, & 6629459

CoreLok[®] Operator's Guide

Table of contents

<i>Introduction</i>	<i>1</i>
<i>System Overview</i>	<i>1</i>
<i>Critical Measurement Parameters</i>	<i>1</i>
<i>CoreLok Applications</i>	<i>3</i>
<i>Safety Precautions</i>	<i>4</i>
<i>Product Specifications</i>	<i>4</i>
<i>Standard & Optional Accessories</i>	<i>5</i>
<i>Control Panel</i>	<i>6</i>
<i>Installation of the GravitySuite™ Software</i>	<i>7</i>
<i>Getting Started with the CoreLok</i>	<i>8</i>
<i>Bulk Specific Gravity of Compacted Asphalt Samples</i>	<i>9</i>
<i>Sample Sealing Process</i>	<i>11</i>
<i>CoreLok Bulk Specific Gravity Data Collection Table</i>	<i>12</i>
<i>Additional Procedures and Information</i>	<i>13</i>
<i>Maximum Specific Gravity (G_{mm}) of Loose Asphalt Mixtures</i>	<i>14</i>
<i>Apparent Specific Gravity of Fine and Coarse Aggregates</i>	<i>17</i>
<i>CoreLok Max/Apparent Gravity Data Collection Table</i>	<i>19</i>
<i>Porosity/Permeability Procedure</i>	<i>20</i>
<i>Small Bag Apparent Gravity Table</i>	<i>23</i>
<i>Large Bag Apparent Gravity Table</i>	<i>24</i>
<i>Double bag procedure</i>	<i>25</i>
<i>Appendix</i>	<i>26</i>
<i>CoreLok Routine Care</i>	<i>27</i>
<i>CoreLok Maintenance Schedule</i>	<i>29</i>
<i>Troubleshooting</i>	<i>36</i>
<i>Warranty</i>	<i>37</i>
<i>Conversion Table</i>	<i>38</i>

Introduction

Increase in the use of coarse and open graded mixes has created a need for more reliable and accurate method of bulk specific gravity measurement of laboratory and field specimens. Open graded mixes readily absorb water and drain quickly when removed from the water tank. The lack of control over the penetration and drainage of water in and out of asphalt samples creates a fundamental problem with the water displacement measurement using the current principles for determination of specific gravity.

The most efficient and accurate method of correcting for this problem is to seal the samples prior to testing in water. The current sealing methods, namely, Paraffin and Parafilm are optimized for 100-mm diameter samples. They are difficult to impossible to use effectively for 150-mm samples and cause large measurement variability. The new system explained in this manual provides an advanced and automatic solution to sealing asphalt samples.

The CoreLok system is a vacuum chamber that is used with specially designed polymer bags to completely seal field and laboratory asphalt samples from water during the bulk specific gravity measurements.

The CoreLok is a versatile density system with many different applications. This device can be used for determination of bulk gravity of compacted asphalt samples (ASTM D6752 & AASHTO T331), maximum gravity of loose asphalt samples (ASTM D6857), porosity or permeability of compacted field or laboratory samples (ASTM D7063), and gravity and absorption of fine and coarse aggregates (ASTM D7370).

System Overview

The CoreLok uses a 1.25 hp vacuum pump in conjunction with control electronics and a vacuum tight chamber to seal samples. The system is completely integrated and operates on 120 or 220-volt (optional) power. The sample is placed inside a specially designed plastic polymer bag, inserted in the chamber and the door is closed. A switch recognizes the door closure and activates the vacuum pump. The vacuum pump operates until the vacuum gauge indicates 99% of full vacuum. An integrated pressure gauge monitors the vacuum level and displays the vacuum within the chamber. The pump is capable of producing 29.7 inches of Hg vacuum. At this point the chamber and the bag are close to absolute vacuum. An automatic sealing strip heat-seals the bag at the open end and air is allowed to enter the chamber in a controlled manner. Since the bag is sealed and is under vacuum, the increased pressure in the chamber forces the plastic bag around the sample creating a tightly vacuum-sealed sample. Once the chamber reaches atmospheric pressure, the chamber door automatically opens. The sample can be removed and tested. The bag density is known and accounted for in the calculation of the bulk specific gravity.

Critical Measurement Parameters

The following three aspects are important and should be recognized when using the CoreLok system:

- 1- Vacuum pressure
 - 2- Testing time after sealing
 - 3- Sample temperature prior to sealing
- 1- *Vacuum Pressure.* The pump should be able to create a vacuum of 29.7 in. Hg inside the chamber. The residual volume after sealing the sample should be less than 2% by volume of the specimen, the limit required by the current ASTM D1188 for sealing asphalt specimens. The calculation based on an asphalt sample 5" in height and 6" in diameter with a volume of 141.4 in³ and 1% residual volume yields a pressure of 0.3 in. Hg

using Boyle's Law, which would indicate a vacuum pump requirement capable of 29.7 in. Hg (30-0.3 in. Hg) of vacuum.

$$P_1V_1 = P_2 V_2$$

Where, P_2 is the pressure on the bag during the sealing process, V_2 is the void volume not occupied by the plastic bag after sealing and V_1 is the total air volume of the bag not occupied by the core.

The vacuum performance of the unit should be checked at least once every three months by using an absolute vacuum gauge that can be placed directly inside the chamber. This will ensure the integrity of the pump, vacuum hoses and the seals.

- 2- *Testing time after sealing.* The CoreLok plastic bags are designed with multi-composition layers of plastic. The requirement for the plastic is to be flexible to conform to the sample and to provide enough strength to resist punctures from asphalt samples. To accomplish this specification the molecular structure of the bag is designed to hold vacuum levels produced by the CoreLok for approximately one hour. The testing procedures should be written such that the water displacement test is conducted within 2 minutes after the sealing process. Samples can be tested after this time but two items have to be looked at prior to testing. First, a major leak can occur in the bag by mishandling of the bag before or after the sealing process. This could easily be seen within a few seconds of sealing. With careful handling, most of these leaks can be avoided. Second, due to excessive stretching of the plastic around sharp points, "micro" leaks can occur. This can be defined as thinning of the plastic, which will allow air into the bag over a very long time (hours). This does not affect the results if the sample is tested within the first 30 minutes of the sealing process. The surface tension on the bag is sufficient to keep water out of the bag.

For best results, the bag should be checked prior to testing to ensure tight fit around the sample. Presence of a major leak is obvious in this process with immediate loosening of the bag.

- 3- *Sample temperature prior to sealing.* Introduction of air into the chamber after heat- sealing the bag is done in a controlled manner to avoid artificial compaction of the sample in the chamber. The bag conforms to the sample in a slow and methodical way. Tests with the CoreLok indicate that temperatures below 120° F will not affect the sample density. It is recommended that samples be cooled to this temperature prior to sealing.

Table 1, shows data on nine different asphalt samples tested at room temperature, 120°F, 150°F and 200°F. The density errors as seen from this test range from 0 to 0.019 g/cm³. The maximum error occurred at 150°F on a coarse graded mix. To ensure accurate density measurements by the CoreLok test, we recommend temperatures of less than 120°F.

Table 1: Density (g/cm³) of Samples Tested in the CoreLok at Different Temperatures.

Sample	Density @ Room Temp g/cm ³	Density @ 120°F	Density @ 150°F	Density @ 200°F	Difference g/cm ³
1, Fine	2.310		2.303		0.007
2, Fine	2.273		2.265		0.008
3, Coarse	2.214		2.233		0.019
4, Coarse	2.097	2.105			0.008
5, Fine	2.302	2.304			0.002
6, Fine	2.282	2.282			0.000
7, Fine	2.308			2.300	0.008
8, Coarse	2.210			2.219	0.009

CoreLok Applications

In addition to measuring bulk specific gravity of compacted specimens, the CoreLok can also be used for the following applications:

- 1- Maximum specific gravity (G_{mm}) or “Rice” specific gravity of loose asphalt mixtures. Special channel bags are required for this test.
- 2- Apparent specific gravity of fine and coarse aggregates.
- 3- Bulk specific gravity and absorption of fine and coarse aggregates.
- 4- Porosity or permeability of field and laboratory samples.
- 5- Indirect determination of percent asphalt content

Refer to the table of contents or call InstroTek for instruction regarding the above procedures.

Safety Precautions

Always follow these basic safety precautions when using electrical or pump appliances:

- Read all instructions carefully.
- Take notice of all warning labels located on the CoreLok.
- Do not tip the CoreLok on its side.
- Do not use on wet surfaces.
- Do not immerse any part of the CoreLok, the CoreLok cord or plug into water or other liquids.
- To disconnect, grip plug and pull from wall outlet. Do not disconnect by pulling on the cord.
- Do not allow cord to dangle over or touch hot surfaces.
- Do not operate the CoreLok if the cord is damaged in any way.
- Do not place on or near a heat source.
- Use of accessory attachments not recommended or sold by InstroTek, Inc. may be dangerous and may void your warranty.
- Do not operate the CoreLok with the housing removed.
- Do not operate if the chamber lid appears to be damaged or cracked.
- Do not lay hand on the intake to check pump suction. Exposure of any part of the body to the vacuum can result in personal injury to the exposed part.
- Never operate the pump with an open, accessible inlet. Vacuum connections, oil filling opening or oil draining opening must not be opened during operation of the pump.
- Beware of hot surfaces that can cause burns. The operating pump can have surfaces that reach temperatures higher than 80 C (176 F). The bag sealing edge will still be hot immediately after operation, avoid contact.
- Only allow authorized personnel with proper machinery operating knowledge to transport, install, operate, perform maintenance (servicing) or dispose of hazardous wastes.
- Do not use for other than intended use.

Product Specifications

Overall Size	19" X 19" X 25" (483 X 483 X 635 mm) (W X H X Depth)
Chamber Size	16.75" X 7.25" X 19.6" (425 X 184 X 497 mm) (W X H X Depth)
Seal Bar	16.0" (406 mm)
Pump	Busch 1.25 h.p.
Vacuum Level	29.95" Hg, 1 TORR, 1.33 mbars
Mode of Operation	Automatic and controlled by a gauge to 99% of full vacuum
Electrical Specification	120 VAC, 60 Hz, 13 amps or optional 220 VAC, 50 Hz, 6.5 amps
Filler Plate	3-3/4" (19mm)
Footprint	3.25 sq. ft.
Net Weight	120 lbs. (53 kg)

Standard Accessories:

- 1 – Water Tank (24" x 18" x 18")
- 2 – Over Flow Container
- 3 – Hanging Basket
- 4 – Core Edge Breaker
- 5 – Operation Manual (CD)
- 6 – Scissors
- 7 – Sliding Plate
- 8 – Small Sample Bags (10" x 14")
- 9 – Channel Bags for G_{mm} Testing
- 10 – Large Sample Bags (15" x 18")
- 11 – Hanging Rod
- 12 – Filler Plates
- Not Shown – Protective Cover



Tank Stand

Optional Accessories



Scales



AggPlus

Please call InstroTek, Inc. if you need to purchase any optional accessories

Control Panel



Factory Settings

Control	Program #1	Program #2	Description
Power Switch	On	On	Operation begins when lid is closed.
Vacuum Control	99%	99%	Vacuum within chamber is 99% of absolute vacuum.
Dwell	15	300	Ensures that a vacuum of 99% is achieved.
Seal	1.0	1.0	Time setting of seal bar.



Installation of the GravitySuite™ Software

GravitySuite™ from InstroTek is provided with each CoreLok. This software is also available on our web site at www.instrotek.com. This package will allow you to enter information necessary to automatically calculate bulk specific gravity with the CoreGravity™ software, maximum (apparent) specific gravity with MaxGravity™ software, Aggregate bulk gravity, absorption and apparent gravity with AggSpec™ and Porosity or Permeability with Porosity program.

- 1- Install the GravitySuite package on Windows 95 or a higher windows version.
- 2- Place the disk in the appropriate drive.
- 3- Select the "Start" from Windows.
- 4- Select 'Run'.
- 5- Type "?:\GravitySuite.exe" where ? is the appropriate drive for your CD-ROM.
- 6- Follow the prompts.
- 7- The program will install on your computer and will automatically place an icon on your desktop.
- 8- **Optional:** You might need to use the rubber sheets for maximum specific gravity tests. Please review the maximum gravity procedures and if rubber sheets are required for your test, contact InstroTek. When you receive the rubber sheets, note that a density value is written on the corner of each sheet. Write this value in your manual for future reference. You will enter this value into the program by first opening MaxGravity. Weigh the rubber sheets and enter the weight in MaxGravity software. The program will ask for the density of the rubber sheets. Enter the password - **DENSITY**. Once the password is entered, enter the density value written on the rubber sheets. *If the rubber sheets are replaced, a new density must be entered.* The software will now automatically correct for the rubber sheets.
- 9- You are now ready to use this program

Getting Started with the CoreLok

Comply with all the items in this section prior to operation of the CoreLok.

CoreLok Bags.	<p>Use only bags that are provided by InstroTek, Inc. Polymer bags should be handled with care. Small holes can develop in bags that are mistreated and render them useless for effective sealing. During transportation, store the bags in a safe, protected place. Bag sizes are critical for optimum vacuum operation. Two different size puncture-resistant bags are provided for use with both small and large cores.</p> <ul style="list-style-type: none"> • For all 4" cores and for 6" cores up to 2" thick, use the small bags (10" X 14"). • For all other large sizes, use the large bags (15" X 18"). • For special sample types and shapes, contact InstroTek, Inc. <p>Bag color may vary depending on the date of manufacture.</p>
SEAL	<p>The SEAL time is set at the factory for 1.0 seconds, however, this may be adjusted by the user if there is evidence that bags are not sealing completely or the bags are melting beyond the needed SEAL time. To change this setting press the MENU button until "SEAL 1.0" is displayed on the screen, use the UP or DOWN arrow buttons to extend or shorten the SEAL time, finally press the MENU button to return to the PROGRAM# screen</p>
Stop	<p>Before operating, check proper oil level. See Illustration in Appendix page 32. Oil level should register between $\frac{1}{2}$ and $\frac{3}{4}$ level on the pump sight glass visible by removing the stainless steel chassis. Operation of the pump, even for a few seconds, without oil can cause extensive wear and damage. If oil needs to be added, refer to the Maintenance section of the Operator's Guide.</p>
Caution	<p>Pumps that have been filled with oil must only be moved in the upright position (horizontally). The angle of slope may not be over 10° maximum. Otherwise, oil may escape. Avoid any other orientations while moving the pump. Never tip the CoreLok on its side!</p>
Warning	<p>Make sure that the unit rests on a sturdy, flat surface. If you intend to place the unit on a mobile cart, make sure that the cart is able to support the weight and that the cart is large enough to allow the unit to rest on its feet as designed. Units should never be placed so that they are resting off the edge of a counter or cart.</p>
Warning	<p>Plug the unit into a properly installed, rated and grounded receptacle. Never remove the grounding pin. Do not plug the unit to an extension cord.</p>
Warning	<p>Check the pump for the presence of any oil leaks, because there is the danger that someone may slip on oil that may have leaked from the pump.</p>
Caution	<p>The pump's ambient operating temperature should be between 0° C (32° F) and 40° C (104° F).</p>

Bulk Specific Gravity (G_{mb}) of Compacted Asphalt Specimens

ASTM D6752 & AASHTO T 331

The following procedure can be used as an alternative to ASTM D2726 & T166 for determination of bulk specific gravity of compacted asphalt specimens. This procedure requires that a dry compacted asphalt specimen be placed inside a bag and vacuum-sealed with the CoreLok. The bag is then placed underwater and a submerged weight is determined. The weight in air and the submerged weight can be used to calculate the bulk specific gravity of the asphalt specimen.

Note: The latest version of the GravitySuite™ software can be downloaded from our web site at www.instroke.com

Important: To avoid errors in submerged weight of the sample, use a large water tank. The minimum recommended dimensions for the tank are 610(L) X460(W) X460(D) mm (24X18X18 in). See “CoreLok Bags” on page 8 for correct bag size usage.

Note: Make certain the sample is at room temperature and removed of loose debris and sharp edges—use the CoreEdge Breaker to knock down the rough specimen edges—before beginning the test.

Procedure

- 1- The CoreLok machine should be set according to the procedures outlined under CoreLok Operation manual. Select Program #1. In Program #1, the Dwell time is set at the factory, thus making sure that all trapped air is removed out of the bags.
- 2- Place enough filler plates inside the CoreLok to ensure the specimen will not impede the machine lid from closing. You will need the sliding plate for this test so this height will also need to be taken into account.
- 3- Select a appropriate size bag (see above for core size information). Inspect the bag for holes or stress points. Do not use the bag if you find holes or stress points.
- 4- Weigh the bag, record the total weight in column A of the Bulk Specific Gravity Data Collection Table (pg 12).
- 5- Weigh the dry sample and record the sample weight in column B.
- 6- Place the empty bag inside the CoreLok chamber.
- 7- Gently place the core inside the bag ensuring the core is resting on top of the sliding plate care is taken to not puncture the bag.
- 8- Place the bag opening over the seal bar with approximately 1” overlap and close the chamber door. After the vacuum and sealing operation, the chamber door will open. See “SEAL” on page 9 for additional information.
- 9- Gently remove the sealed sample from the chamber and immediately transfer the sample to a large water bath equipped with scales and the cushioned weighing basket. Completely submerge the bag in water.

Caution: Make certain the bag is not touching the sides or bottom of the water tank.

- 10- Allow the scales to stabilize and record the weight in column C.
- 11- Remove the sealed core from the water. Cut open the bag and remove the core. Weigh the core and record the weight in column D.
- 12- Hand-calculate the results or launch the GravitySuite package to automatically calculate the results by using the CoreGravity option.

Sample Preparation

CAUTION

Do Not Test Samples with Jagged Bottom Surface



**CUT THE BOTTOM SURFACE BEFORE TESTING WITH THE
CORELOK**

Sample Sealing Process



1. Place appropriate number of filler plates into the vacuum chamber. One plate is sufficient for 150 mm gyratory specimens.



2. Place sliding plate towards the backside of the chamber on top of the filler plate. Make sure the rubber strips are facing up and the smooth side is resting on the filler plate.

3. Select a bag and inspect the bag for holes or stress points. Weigh the inspected “good” bag.

4. Weigh the dry sample (review Sample preparation step in procedure).



5. Place the bag in the CoreLok and on the sliding plate.

NOTE: The clear bag is shown for illustration only.



6. Place a sample in the bag.



7. Place the bag over the seal bar. Make certain the open end of the bag is approximately 1” over the seal bar.



8. Close the door with both hands and hold down firmly for 2-3 seconds.

9. Allow the CoreLok to perform the vacuum and sealing operation.

10. Carefully remove the sealed sample taking care to not puncture the bag. Submerge the sample using the provided cushion basket.

CoreLok™ Bulk Specific Gravity Data Collection Table

Sample ID	A Bag Weight (g)	B Dry Sample Weight before Sealing (g)	C Sealed Sample Weight in Water (g)	D Dry Sample Weight After Water Submersion	E Ratio B/A	F Bag Apparent Gravity From Table	G Total Volume (A+D) - C	H (Volume of Bag) A/F	I (Volume of Sample) G - H	J Bulk Specific Gravity B/I

Important

- Check bags for holes and stress points prior to use. Do not use damaged bags
- Hang the provided cushioned weighing basket in the water tank from the scale (a hooked rod is provided)
- Use the sliding plate (rubber strips up) in the CoreLok chamber to reduce friction to the bags
- Wipe away loose debris and break sharp points on the sample
- After you load the sample in the bag, do not touch the bag. Adjust the bag position in the chamber by moving the sliding plate
- Never place the sealed sample on a hard surface
- Test the sample immediately or a maximum of 2 minutes after sealing the sample
- Gently shake the sample in the water tank prior to placing in the weighing basket to remove air bubbles
- Place the sample gently in the basket in the water tank.
- Do not drop the sample on the basket or in the water tank
- If weight in column D is greater than 5 grams of weight in column B dry the sample and repeat the test
- Use the provided GravitySuite software to calculate your bulk specific gravity
- Use the double bag procedure for very heavy samples that cause repetitive punctures

ADDITIONAL PROCEDURES AND INFORMATION

Maximum Specific Gravity (G_{mm}) of Loose Asphalt Mixtures

ASTM D6857

The following procedure can be used as an alternative to “Rice” Test AASHTO T209 and ASTM D2041 for determination of maximum specific gravity of loose asphalt mixtures. This procedure requires that a sample of dry asphalt mixture be placed inside two bags and vacuum-sealed with the CoreLok. The bags are then cut open underwater and a submerged weight is determined. The weight in air and the submerged weight can be used to calculate the maximum specific gravity of the asphalt mixture.

Note: The latest version of the GravitySuite™ software can be downloaded from our web site at www.InstroTek.com

Important: To avoid errors in submerged weight of the sample, use a large water tank. The minimum recommended dimensions for the tank are 610(L) X460(W) X460(D) mm (24X18X18 in).

Caution: Accurate sampling is crucial in obtaining repeatable results. Please take care when selecting test samples.

Note: Make certain the sample is at room temperature before beginning the test.

Procedure

- 1- The CoreLok machine should be set to Program #2. In Program #2, the Dwell time is set at 300 seconds, thus making sure that all trapped air is removed out of the bags.
- 2- Place all three filler plates inside the CoreLok. You do not need the sliding plate for this test
- 3- Select a large bag. Inspect the bag for holes or stress points. Do not use the bag if you find holes or stress points.
- 4- Weigh the large bag and one channel bag (the clear bag with one textured side). Record the total weight in column A of the Max/Apparent Gravity Data Collection Table (pg 19).
- 5- Weigh the dry sample and record the sample weight in column B. You may use up to 2000 grams of loose mixture per test.
- 6- Place the sample inside the channel bag.
- 7- Place the empty large bag (external bag) inside the CoreLok chamber.
- 8- Place the channel bag with the rough side down inside the external bag. It is important that the channel side (rough side) of the bag is face down against the bottom. This will help in removing the air from underneath the sample.
- 9- Place your hand inside the channel bag and gently and evenly spread the sample within the channel bag. ***Do not try to spread the sample by squeezing down on the bags. Putting pressure on the bags will create punctures.***
- 10- Push in the opening of the channel bag away from the opening of the external bag. ***Make certain that the channel bag opening is not folded as to restrict airflow out of the bag and the channel bag is about 1” (25mm) away from the closed end of the external bag.***
- 11- Place the external bag opening over the seal bar and close the chamber door. The channel bag should not be over the seal bar.
- 12- After the vacuum and sealing operation the chamber door will open. See “SEAL” on page 9 for additional information.

- 13- Gently remove the sealed sample from the chamber and immediately transfer the sample to a large water bath equipped with scales. Completely submerge the bag in water and while submerged (at least 2" under water) cut the bag under the seal joint but above the channel bag. The bag opening should extend all the way across, leaving approximately 1" intact.

Note: Cutting the bag too close to the water surface will allow air to enter the bag and would negatively impact the result. Always keep the sample a minimum of 2" under water.

- 14- Open both bags while under water and hold open for 15 seconds to allow the water to enter the two bags and wet the sample.

Note: If you notice a massive amount (like boiling water) of bubbles coming out of the bags, then the test should be repeated. The bag has been punctured.

- 15- Carefully fold the bags over and, while keeping them completely under water, place the sample on the provided weighing basket hung from the scale.
 16- While over the weighing basket open the bags and let water freely enter the bags.
 17- If necessary, use the alligator clip tied to the weighing basket to stop the bags from floating above the surface of the water.

Caution: Make certain the bag is not touching the sides or the bottom of the water tank.

- 18- Allow the scales to stabilize and record the weight in column C.
 19- Hand-calculate the results or launch the GravitySuite package to automatically calculate the results by using the MaxGravity option.
 20- Double click on MaxGravity.
 21- Click on Asphalt.
 22- Input the required weights in the appropriate columns in the program. The program will calculate the G_{mm} in g/cm^3 .
 23- The results can be transferred to Microsoft Excel for printing and storage.

Note: You can reuse the channel bag as long as they remain intact. Dry the bags prior to each additional use.

Rubber Sheets:

If the material you are using causes repetitive punctures in the bag, use the provided rubber sheets for added puncture resistance. Punctures during this test will become obvious when the sample is cut in the water tank. A massive amount (like boiling water) of bubbles will come out of the sample and the results as compared to the conventional tests will be lower (more than $0.02 g/cm^3$ different). Rubber sheets can be used inside the large bag, one under the channel bag containing the sample and one above the channel bag. Keep the rubber sheets away from the bag opening. If you have not already entered the rubber sheet densities in the software, simply weigh the rubber sheets and enter the weight in MaxGravity software. The program will ask for the density of the rubber sheets. Enter the password - **DENSITY**. Once the password is entered, enter the density value written on the rubber sheets. Write this value in your manual in case it wears off the sheets. *If the rubber sheets are replaced, a new density must be entered.* The software will now automatically correct for the rubber sheets. The entry of the density of the rubber sheets is also described in the Installation of the GravitySuite Software section. For more information about the use of the rubber sheets, contact InstroTek, Inc. at 919-875-8371.

Sample Sealing Procedures



Place up to 2000 grams in a channeled bag. The textured surface goes down.

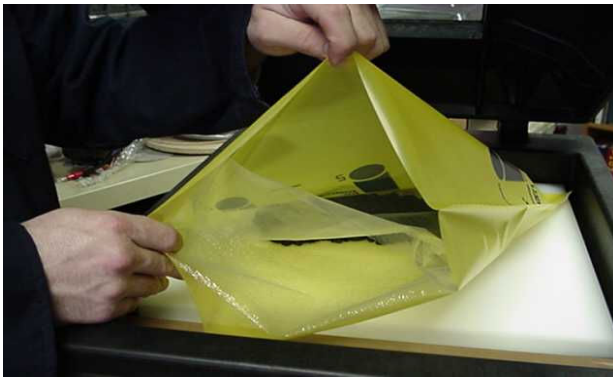

Place the internal channel bag with the textured side down in a second bag. Do not squeeze down on the bags, when spreading the sample

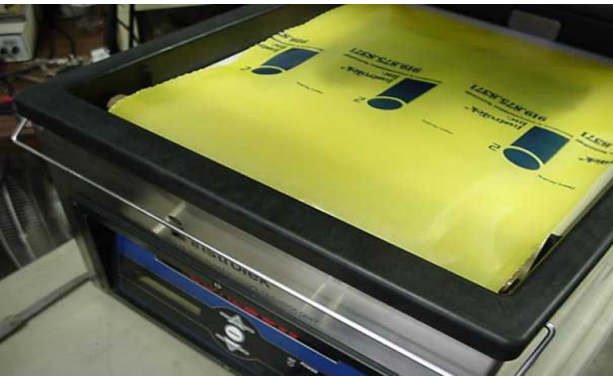

Place the external bag over the seal bar. *Do not seal the channeled bag.*



Carefully remove sealed sample and completely submerge in water tank. Cut the bag under water. The cut profile should extend all the way across; leaving approximately 1" intact (no part of the bag should be above the surface of the water or touching the water tank).

This picture was taken out of water tank for clarity only; this step must be done with sample completely submerged.

Apparent Specific Gravity of Fine and Coarse Aggregates ASTM D7370

The following procedure can be used to calculate the apparent specific gravity of fine and coarse aggregates in approximately 7 minutes using the CoreLok system. In this procedure a sample of oven dry aggregate is placed inside a bag and vacuum-sealed inside the CoreLok machine. The bag is opened under water and weighed while submerged. The dry weight and the submerged weight can be used to calculate the apparent specific gravity.

Note: For large aggregates (0.5 inch or larger) use two bags. Use the rubber sheets if necessary. The procedure outlined for asphalt G_{mm} can be used for large aggregate apparent specific gravity determination.

Procedures

- 1- The CoreLok machine should be set to Program # 2. In Program #2, the Dwell time is set at 300 seconds, thus making sure that all trapped air is removed out of the bags
- 2- Place all three filler plates into the CoreLok chamber. The sliding plate is not needed.
- 3- Weigh an empty large bag and record the weight in column A of the Max/Apparent Gravity Data Collection Table (pg 19).
- 4- Select a representative sample of approximately 1000 to 1500 grams. Make certain the sample is completely dry. Record the sample weight in column B.
- 5- Place the dry aggregate sample in the bag. Support the bottom of the bag on a tabletop to support against puncture and impact points.
- 6- Place the bag containing the sample into the CoreLok.
- 7- Place your hand inside the channel bag and gently and evenly spread the sample within the channel bag. ***Do not try to spread the sample by squeezing down on the bags. Putting pressure on the bags will create punctures.***
- 8- Place the open side of the bag over the seal bar and close the chamber door.
- 9- After the door opens, place the sample in the water for water displacement analysis.
- 10- Cut one corner of the bag, the cut should only be about 1" long. Cutting the bag too far can cause the fines to escape into the water tank. Make sure the bag is completely submerged before cutting. Introducing air into the bag will produce inaccurate results.
- 11- Open the cut portion of the bag with your fingers and allow the water to freely flow into the bag.
- 12- Allow the sample to stay in the water bath for **five** minutes.
- 13- Record the submerged weight in column C.
- 14- Follow the formulas in the data collection table to calculate the apparent specific gravity or use the MaxGravity Software by launching the GravitySuite Package.
- 15- Click on Aggregate and enter all required weights. The program will calculate the apparent specific gravity of your sample. Export your data to Microsoft Excel for printing and storage.

Sample Sealing Procedures



Place up to 1500 grams of aggregate in the bag.

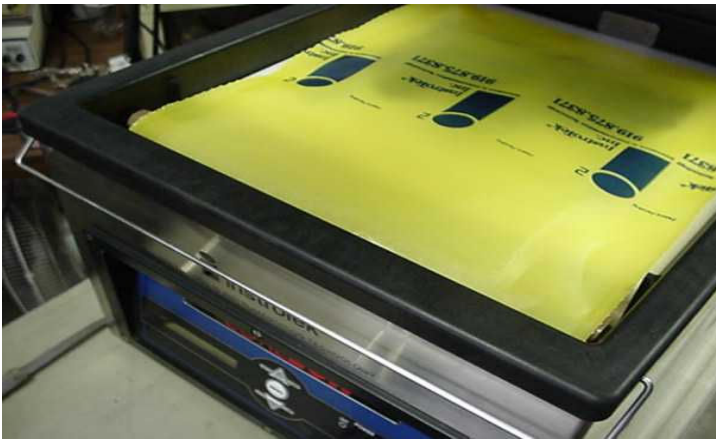

Spread the sample as flat as possible and place the bag opening over the seal bar. Do not spread the sample by squeezing down on the bag.



Cut the bag under water approximately 1" (no part of the bag should be above the surface of the water).

*This picture was taken out of water tank for clarity only; **this step must be done with sample completely submerged.***

CoreLok™ Max/Apparent Gravity Data Collection Table

Sample #	A Bag Weight (grams)	B Weight of Rubber Sheets (grams) (put in 0 if not used)	C Weight of Sample in air (grams)	D Weight of Bags and Sample in Water (grams)	E (A+B+C) – D Total Volume	F A/V _c +B/R _c Bag and rubber sheet Volume	G E-F Sample Volume	H C/G Density

$R_c = \underline{\quad\quad} \text{ g/cm}^3$ (value written on rubber sheets)

$V_c = 0.903 \text{ g/cm}^3$

- Do not squeeze down on the bags, when spreading the sample.
- Before using the large bag, inspect the bag for holes or stress points. Do not use damaged bags.
- Use a large water tank for conducting this test.
- Use all three white filler plates.
- Remove the sliding plate.
- Place rough side of the channeled bag down inside the external bag.
- Immediately place the sealed sample in the water tank.

Important

- To stop the possibility of air from getting into the bag, cut 1" (25mm) of the bag while at least 2" (50mm) under the water.
- Hold the bags open for 15 seconds to allow water to get in
- If you see a massive amount of bubbles (Like boiling water) coming out of the bag, repeat the test.
- While under water, place the sample in the weighing basket
- Use the alligator clip to keep the cut portion of the bag from floating out of water.
- Make sure the bag is not floating out of the water or touching the sides and bottom of the water tank.
- Use the rubber sheet if the material consistently punctures bags.

Determination of Sample Porosity/Permeability using the CoreLok Machine ASTM D7063

Introduction:

In recent years, design and use of open graded mixes has gained popularity. It is important to consider that the use of % Air Voids for design and quality control of these mixes might be misleading for determination of pavement durability. While % Air Voids is a viable design and quality control criteria for fine graded mixes, a more adequate and meaningful method has to be used for open graded mixtures designed for the highway system.

Air void content is of concern primarily for stability and durability of asphalt mixtures. Air void determination during construction is used to protect against excessive water permeability that can cause premature failure. For durability, only the air voids that are accessible to water, the “% Porosity”, is of concern. The concerning fact with the present method is that two samples with 7% air voids can have completely different permeability characteristics depending on the void structure within the sample. However, two samples with the same porosity will have the same permeability. We believe that for open graded mixtures, determination of % Porosity is a better design and pavement quality indicator as compared to the currently determined % Air Voids measurement.

Percent Porosity is defined as the percentage of water permeable voids in the compacted mixture.

This parameter can be calculated by using a bulk specific gravity and an apparent maximum gravity of any compacted sample. This measurement relies completely on the material composition, gradation and structure of the compacted mixture under test. It does not require a previously determined Gmm value, which in most cases is not representative of the gradation of a randomly selected coarse graded compacted sample.

Porosity can be used as a direct indicator of mix durability and will have a strong correlation to mixture permeability and segregation. This test is easy to perform and can be completed in approximately 7 minutes using the CoreLok system. A detailed procedure for conducting this test is attached.

Knowing the total porosity of compacted samples is helpful in determining the performance of pavements with respect to permeability. The present tests for determination of permeability are time consuming and the measurements are based on number of assumption that cannot be defended, physically and theoretically.

The approach in this technique is to determine a fundamental parameter that is not based on any assumptions. In this method a sample is vacuum-sealed inside a bag and a sealed density, ρ_1 is calculated. The same sample, while under water, is opened and a second density, ρ_2 is determined. Since the sample is under complete vacuum prior to opening the bag, ρ_2 will yield an apparent density of the compacted sample. The density ρ_2 includes the volume due to inaccessible air voids. In this method, a standard equation can be used for calculation of % Porosity,

$$\% \text{ Porosity or } \%P = \left(\frac{\rho_2 - \rho_1}{\rho_2} \right) X 100$$

Where:

ρ_1 = the CoreLok vacuum sealed density of compacted sample

ρ_2 = Density of the vacuum sealed sample after opening under water

Definitions:

% Porosity- the % air void in the compacted sample that is accessible to water and that are interconnected.

Indications:

- 1- It is expected that the %P will increase with increase in air void content as determined by the ratio of CoreLok machine bulk density (G_{mb}) and maximum density (G_{mm}).
- 2- It is expected that increase in %P will indicate higher potential of mix permeability. Studies have shown that mixtures with %P larger than 7% are highly permeable.
- 3- %P can be correlated to field or laboratory parameters presently in use.
- 4- Since the CoreLok method is fast, %P can be a quick indicator of field permeability.
- 5- This method can also be used during design to determine the permeability potential of mixes.

Procedure:

- 1- Set CoreLok to Program #2 using the up and down arrows on the front panel.
- 2- Inspect an appropriate size bag for holes or stress point. Do not use the bag if it is damaged.
- 3- Obtain an empty bag weight, record in Column A of the Porosity Data Collection Sheet. (pg 22).
- 4- Weigh an appropriate size compacted and dry asphalt sample.
- 5- Record the dry sample weight in Column B.
- 6- Seal the sample inside the bag using the procedures outlined in the CoreLok manual.
- 7- Submerge the sealed sample and wait until the scale stabilizes.
- 8- Record the weight in Column C.
- 9- While the sample is still submerged under water, cut the bag open with scissors.
- 10- Allow water to enter the bag.
- 11- Leave the sample under water for 4 minutes. Make sure the bag is not floating out of the water and it is not touching the sides or the bottom of the tank.
- 12- Record the weight in Column D.

Calculations:

The calculations can be performed by using the Porosity program in the provided GravitySuite™ software. Just input the weights in the columns provided and the program will automatically calculate % Porosity. Also, if you input the maximum specific gravity (G_{mm}) in the program, % Air Voids is calculated for comparison purposes.

Alternatively, you can use the standard equations given in ASTM D6752 to calculate the bulk sealed density of the sample, ρ_1 , and PS132-01 to calculate the maximum (or apparent) density, ρ_2 , of the compacted sample. Use the equation given above to calculate %Porosity.

CoreLok™ %Porosity Data Collection Table

Sample ID	A Bag Weight (g)	B Dry Sample Weight before Sealing (g)	C Sealed Sample Weight in Water (g)	D Sample weight after Cutting the Bag (g)

Small Bag (10 X 14") Apparent Gravity
-0.000566*R+0.8121

R = Ratio M_c/M_b	Apparent Gravity
10	0.806
20	0.801
30	0.795
40	0.789
50	0.784
60	0.778
70	0.773
80	0.767
90	0.761
100	0.756
110	0.750
120	0.744
130	0.739
140	0.733
150	0.727
160	0.722
170	0.716
180	0.710
190	0.705
200	0.699
210	0.693
220	0.688
230	0.682
240	0.676
250	0.671
260	0.665
270	0.659
280	0.654
290	0.648
300	0.642

M_c = mass of dry core (column B) M_b = mass of bag (column A)

Large Bag (14.75 X18 ") Apparent Gravity
-0.00166*R+0.8596

R = Ratio M_c/M_b	Apparent Gravity
10	0.843
20	0.826
30	0.810
40	0.793
50	0.777
60	0.760
70	0.744
80	0.727
90	0.710
100	0.694
110	0.677
120	0.661
130	0.644
140	0.627
150	0.611
160	0.594
170	0.578
180	0.561
190	0.545
200	0.528
210	0.511
220	0.495
230	0.478
240	0.462
250	0.445
260	0.428
270	0.412
280	0.395
290	0.379
300	0.362

M_c = mass of dry core (column B) M_b = mass of bag (column A)

Double Bag Apparent Gravity -0.0022448*R+0.81518

R = Ratio M_c/M_b	Apparent Gravity
10	0.793
20	0.770
30	0.748
40	0.725
50	0.703
60	0.680
70	0.658
80	0.636
90	0.613
100	0.591
110	0.568
120	0.546
130	0.523
140	0.501
150	0.478
160	0.456
170	0.434
180	0.411
190	0.389
200	0.366

M_c =mass of dry sample M_b = total mass of both bags

If you encounter large samples with extremely rough texture, you may double bag the sample to avoid repetitive punctures. Use the following procedure to double bag the sample.

Procedure for Using Two Bags

1. Use two large bags.
2. Cut one of the large bags to a length of **14.5 inches \pm 1/2 inch.**
3. Use the CoreLok Bulk Specific Gravity data collection table. (pg 12)
4. Weigh both bags and record the weight
5. Place the sample into the cut bag.
6. Place the sample and the cut bag into the uncut large bag inside the chamber. Make sure the sample is completely inside the cut bag.
7. Be sure both bags are as flat or smooth as possible; the inner bag should not be bunched or crumpled up.
8. When sealing make sure the inner cut bag is below the seal bar so that only the outer bag is being sealed.
9. Use the CoreLok sealing steps to seal the sample. Make sure the total weight of both bags is entered in the bag weight column of the data collection table and use the table above for bag corrections. You may use the GravitySuite™ PC software and the CoreGravity™ option to automatically calculate the bulk specific gravity. Simply click on the double bag method option and enter your weights for automatic calculations of the results.

Note: The cut inner bag can be reused.

APPENDIX

CoreLok Routine Maintenance

The CoreLok has been designed with ease of use and low maintenance in mind. Follow these routine care and inspections for years of trouble-free operation:

Cleaning

- Unplug the unit.
- Use a warm, damp washcloth with dishwashing soap on all exposed surfaces.
- Clean daily for best results.

Caution: Do not clean the CoreLok with abrasive cleansers or solvents. Softer surfaces such as the lid and base will scratch and discolor.

Periodic Maintenance

Check the following parts on a weekly basis: **(pg 28)**

- Oil level and condition **(fig 1)**
- Silicon seal pad in lid **(fig 2)**
- Sealing gasket in lid **(fig 3)**
- Seal bar Teflon tape and seal element **(fig 4)**
- CoreLok lid and glass viewing window **(fig 5)**

If any of these items are not in working condition or are damaged, replace at once. Do not continue to use the CoreLok until the damaged parts are replaced. Contact InstroTek for replacement parts.

Yearly Maintenance

Replace the following parts on a yearly basis or as needed:

- Vacuum oil **(pg 29)**
- Exhaust filter **(pg 31)**
- Seal element and Teflon tape of the seal bar **(pg 33)**

Periodic Maintenance

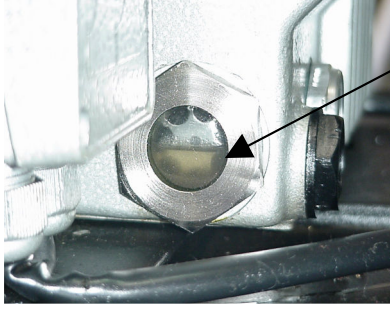

Figure 1: Check the oil level and condition.

Level: The pump's oil level during operation must always be $\frac{1}{2}$ to $\frac{3}{4}$ full on the oil-level sight glass. When necessary, switch off the pump and add the correct quantity of oil. Overfilling can lead to oil losses at high intake pressures. High oil consumption often indicates that the exhaust filter is clogged.

Condition: Normally the oil is clear and transparent. If it darkens, then it should be changed.

Figure 2: Check the silicon seal pad in the top of the lid. The silicon seal pad should not be burnt or worn.

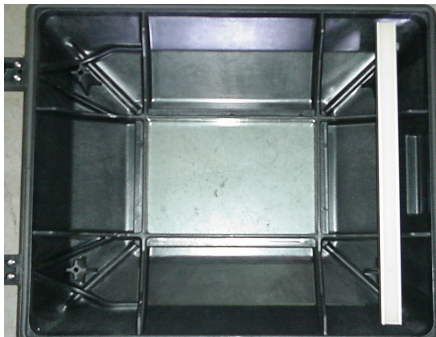
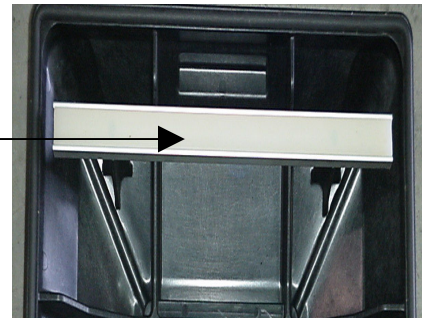

Figure 3: Check the sealing gasket in the lid. The sealing gasket should completely cover the outer edges of the lid. Make sure there are no gaps or tears in the gasket.

Figure 4: Check the seal bar Teflon tape and seal element. The seal tape and element should not be burnt or worn.

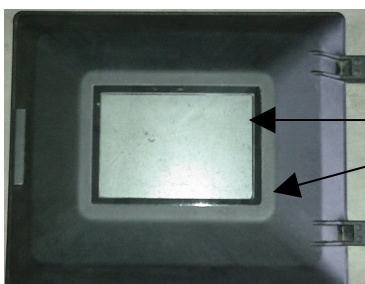
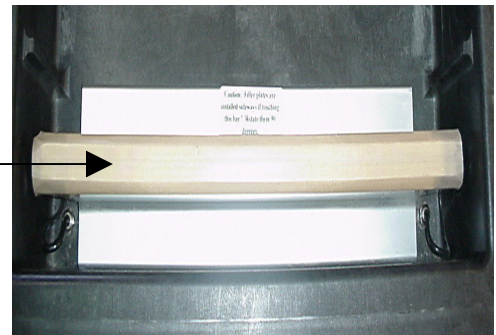

Figure 5: Check the CoreLok lid and glass viewing window. The lid and window should not be stressed or cracked.

CoreLok Maintenance Schedule

All work must be performed by suitably trained personnel. Maintenance or repairs carried out incorrectly will affect the life and performance of the pump and may cause problems when filing warranty claims.

The frequencies stated in the maintenance schedule are approximate values for normal pump operation. Unfavorable ambient conditions, frequency of use and/or aggressive media may necessitate more frequent maintenance.

Maintenance Required	Frequency	Procedure
<p>Replace the pump oil</p> <p>Filling the pump oil Use only the synthetic oil made for this pump. Call InstroTek, Inc. for oil. The pump holds approx. ½ quart of oil.</p> <p>Observe safety regulations and use common sense when working around the pump. The pump and oil can be very HOT.</p> <p>When disposing of used oil please observe the relevant environmental regulations!</p>	<p>500 hours or annually, whichever comes first</p>	<ol style="list-style-type: none"> 1. Unplug the unit from the wall receptacle. Change oil with pump warm. The pump gets hot and could cause burns. Use caution while working around the pump. 2. Remove the two screws located on the bottom back panel of the stainless steel chassis. (fig 1, pg 30) 3. Lift the stainless steel chassis up and towards the front of the unit. Place a pad under the front to protect the switches. (fig 2, pg 30) 4. Pull the side of the unit with the oil sight glass approximately 4" off the work surface. 5. Hold a catch pan under the hole leading to the drain plug. 6. Unscrew the drain plug and allow the oil to flow through the designed channel into the catch pan 7. Reinsert the oil-drain plug and clean around the drain area. <p><i>Never operate the unit, even for short periods without proper level of oil.</i></p> <ol style="list-style-type: none"> 1. Locate the oil fill port on the pump. (fig 1, pg 30). 2. Unscrew the fill plug. Add oil (use a funnel to prevent spills). Add oil until the level registers ½ to ¾ full on the sight glass. Approximately ½ quart. <p>DO NOT OVERFILL!</p> <ol style="list-style-type: none"> 3. Replace the oil fill plug. Hand-tighten only. 4. The exhaust filter should be changed when the oil is changed, see page 3 for instructions.

Pump Fill & Drain Instruction

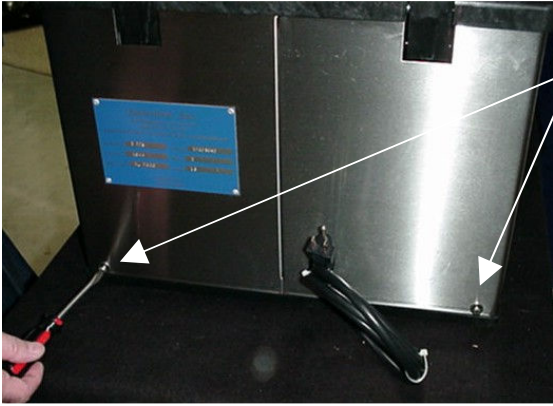
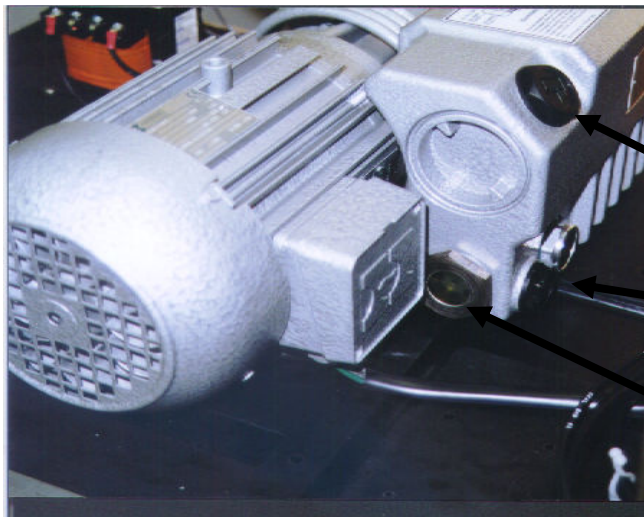

Figure 1: Unscrew two bottom back panel screws.



Figure 2: Remove the filler plates and sample from inside the vacuum chamber. Cushion the front of unit with a pad and lift up and forward.

Figure 3: Drain and Fill using appropriate plug location.



Fill Plug / Oil Fill Port

Drain Plug

Sight Glass

Approved Lubricants

The pump should be run with 10-weight synthetic oil. If you use non-approved oil, there is no guarantee the pump will meet operating specifications (ultimate pressure, pumping speed, operating temperature, etc.) However, the warranty is voided only if the non-approved oil adversely affects the operation or reliability of the pump. Call InstroTek, Inc. for replacement oil when oil changes are required.

Maintenance Required	Frequency	Procedure
Replace the exhaust filter	500 hours or annually, whichever comes first (should be done whenever the oil is changed)	<ol style="list-style-type: none"> 1. Remove the 2 screws holding the fan cover in place. (fig 1, pg 32) 2. Remove the 4 hex head cap screws holding the exhaust silencer in place (fig 2, pg 32) 3. Remove the polyester filter (fig 3, pg 32) 4. Remove the machine screw holding the filter spring assembly in place (fig 4, pg 32) 5. Pull the exhaust filter out, ensure the O-Ring is removed, and discard both. (fig 5, pg 32) 6. Slide the new exhaust filter into the oil pump making sure that the O-ring fits tightly in the exhaust port. 7. Replace the filter spring assembly making sure that the exhaust filter is snug inside the pump. 8. Replace the polyester filter. 9. Put the exhaust silencer back into place and replace the 4 hex head cap screws. 10. Put the fan cover back into place and replace the 2 screws. 11. Once the oil and exhaust filter are changed, carefully push the vacuum hose inside the chassis and close the chassis. Replace and tighten the two screws on the back

Exhaust Filter Replacement

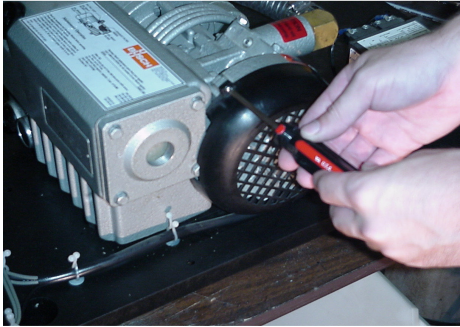

Figure 1: Remove the 2 screws holding the fan cover in place.

Figure 2: Remove the 4 hex head cap screws holding the exhaust silencer in place

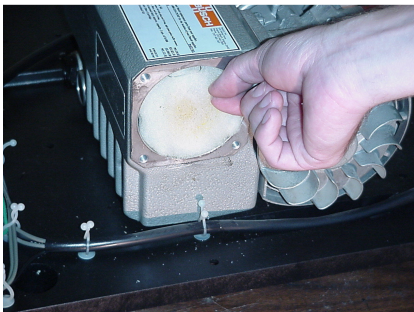
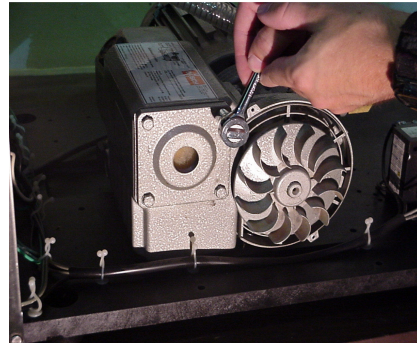

Figure 3: Remove the polyester filter

Figure 4: Remove the machine screw holding the filter spring assembly in place.

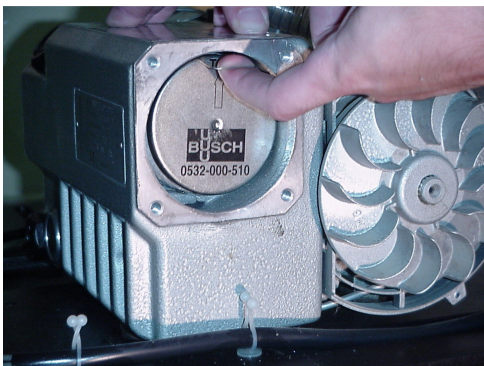
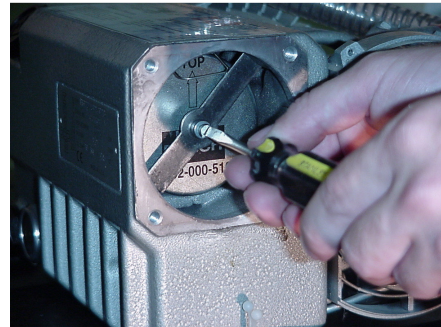

Figure 5: Pull the exhaust filter out and discard.

Maintenance Required	Frequency	Procedure
Replace the seal element of the seal bar	Once the seal element starts to burn through the Teflon tape	<ol style="list-style-type: none"> 1. Turn off CoreLok and unplug the power cord. 2. Open the chamber door. 3. Unplug the two wires from the sides of the seal bar assembly. 4. Remove the seal bar from the machine by lifting straight up on the seal bar. 5. Pull off the Teflon tape strip and discard. Clean off any remaining Teflon tape adhesive using acetone or an equivalent solvent. (fig 1, pg 34) 6. Using a 2mm Allen wrench, loosen the setscrew for the seal wire on both sides of the seal bar. (fig 2, pg 34) Discard the seal wire and fiberglass insulator strip. 7. Once the seal bar is completely clean of any residue, place the new fiberglass insulator strip on the seal bar. Insert the free end of the new seal wire through the slot in the brass contact and tighten the setscrew. 8. Insert the other end through the slot and in the brass contact. Feed the end of the seal wire through the tightening tool so that the seal wire winds around it. Place a slotted tip screwdriver up against the bottom edge of the brass contact while you continue to tighten the seal wire with the tightening tool. (fig 3, pg 34) Note: The slotted tip screwdriver is used as a rest for the tightening tool. If you don't use it, then you might break the seal wire off at the bottom of the brass contact. Secure the seal wire in place by tightening the setscrew with the allen wrench. 9. Apply the new Teflon tape evenly over the seal bar. 10. Reinstall the seal bar and connect the wires on both sides of the seal bar assembly.

Seal Element Replacement

TEFLON TAPE

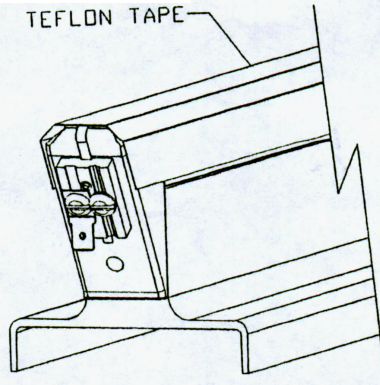

Figure 1

SEAL ELEMENT

SET SCREW

INSULATOR STRIP

2MM METRIC ALLEN WRENCH

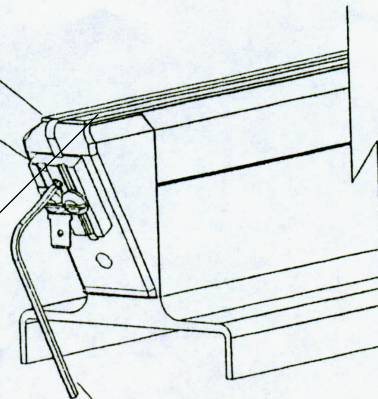

Figure 2

BRASS CONTACT

Figure 3

SLOTTED TIP SCREWDRIVER

TIGHTENING TOOL

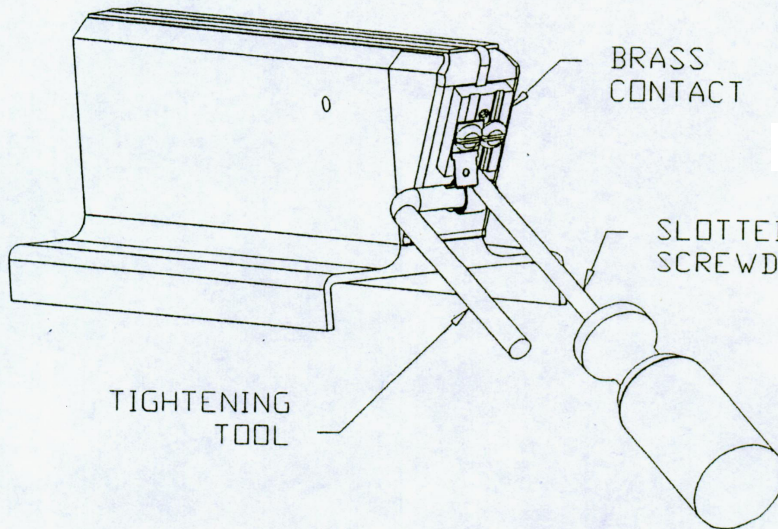

Troubleshooting

Symptom	Possible Cause	Check To See If:
No Power (Vacuum pump does not run)	Power switch off.	Power switch located on right of control panel may be off. Switch to "ON" position (display will light up).
	Lid not closing.	The sample is too large. Remove one or more filler plates.
	Power cord loose or damaged.	Check to ensure wall outlet is working. Plug in a different appliance to verify. Power cord attached securely?
	Blown fuse.	Check fuse on front panel. (pg 36)
No Vacuum (pump runs but lid does not stay closed)	Seal gasket problem.	Check black seal gasket in the lid. It should be seated evenly in the groove and there should not be any cuts, gaps or debris.
	Vacuum ports are blocked or clogged.	The bag is blocking the two vacuum ports in the rear of the chamber. Your bag may need to be repositioned.
	Cut or disconnected hose.	Hose accidentally cut or disconnected during recent servicing or oil change. Contact InstroTek.
No Seal	Damaged or broken seal wire.	Call for replacement seal bar or wire and tape.
	Blown Fuse	Check fuse on front panel. (pg 36)
Inadequate Seal (seal appears too light, spotty, or inconsistent from end to end)	Wrinkles in the bag or debris in the sealing area.	If the sealing surface in the bag is smooth, clean and free of debris. If the sample is too big for the bag, you may not be able to lay the open end of the bag evenly across the seal bar. Make sure tape over the seal wire is smooth and wrinkle free.
	Incomplete seal joint	Center the bag evenly over the seal bar. Make sure the bag width is not larger than the seal bar width.
	Punctures on the sample edges	Make sure the sliding plate is used with the smooth side down. Make sure the top of the sample is not hitting the chamber door. Remove one or more of the filler plates. Make sure the bags are not damaged by inspecting prior to use
	Damaged or worn silicone seal pad in lid (above seal bar).	The silicone pad is not firmly seated in its holder or it is cut, damaged or not smooth. Replace if necessary.
	Tape on seal bar is not even or smooth.	Worn or frayed. Replace if necessary.

Fuse Location

Fuse Location varies on front panel design

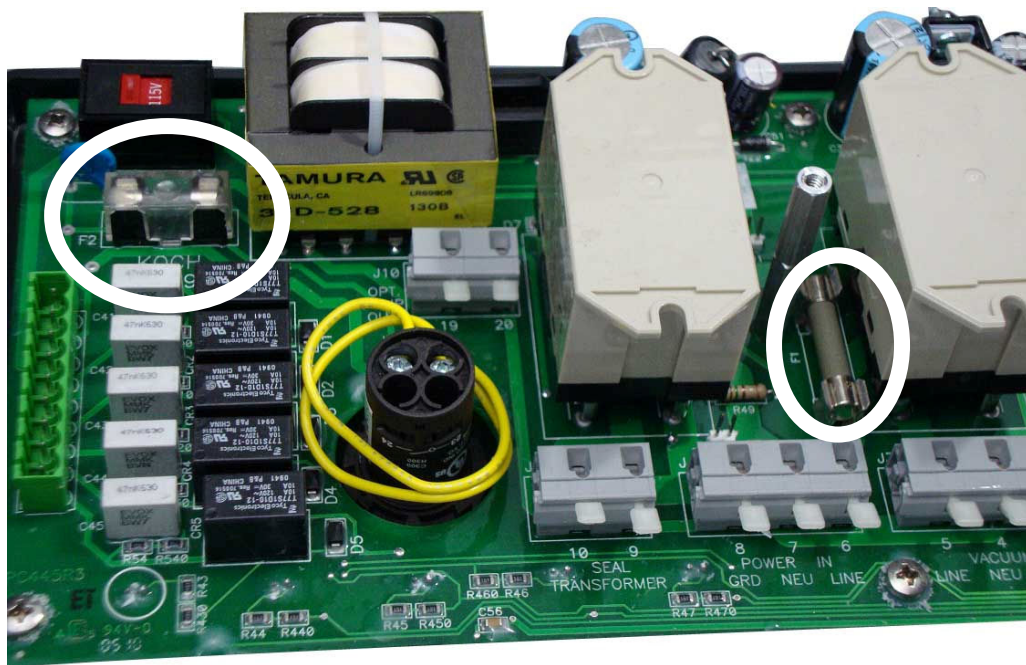
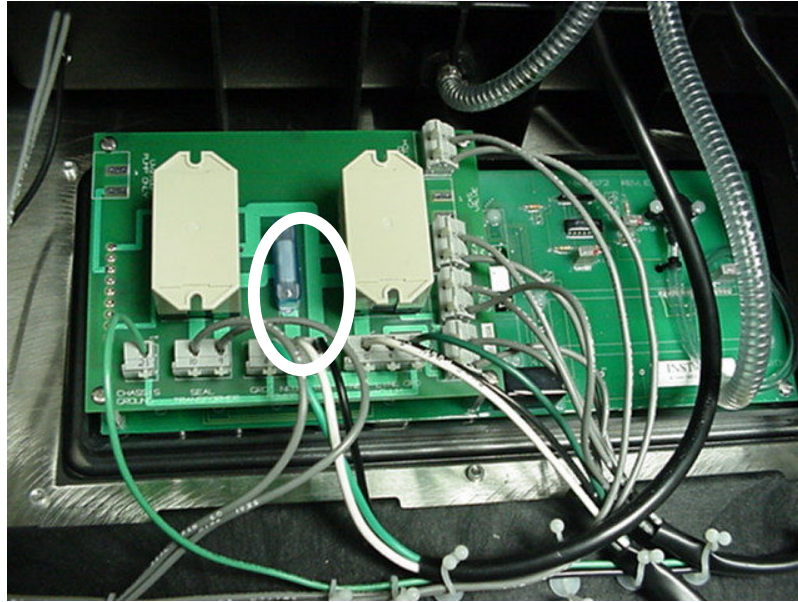

Warranty

InstroTek extends a 2-year warranty on the CoreLok to the original purchaser of this equipment. This warranty covers defects in material, workmanship and operation under the conditions of normal use and proper maintenance. This warranty includes all components except for the normal wear components including the sealing bar Teflon tape, seal wire, silicone seal strip in the lid, and the lid gasket.

InstroTek will replace, free of charge, any part found to be defective within the warranty period.

This warranty is void if inspection shows evidence of abuse, misuse or unauthorized repair.

This warranty covers replacement of defective materials and workmanship only. It does not cover shipping charges, duties or taxes in the transport to and from the factory or authorized service center.

InstroTek's liability is in all cases limited to the replacement price of its products. InstroTek shall not be liable for any other damages, whether consequential, indirect, or incidental arising from use of its product.

If return of the product is necessary, please include return shipping directions, contact name, phone & fax number and a description of the action needed.

Call InstroTek, Inc. for shipping details at (919) 875-8371

Conversion Table

Metric and U.S. Customary Unit Conversions		
Multiply	By	To get
PSI	68.91	mbar
mbar	0.75	Torr
Torr	0.0193	PSI
m ³ /hr	0.589	CFM
inches	25.4	mm
feet	30.48	cm